

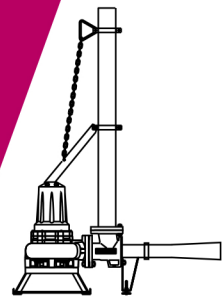

**Submersible Aerators for Waste  
Water Treatment**  
*Aérateurs Submersible pour le  
Traitement des Eaux Usées*  
**Aeratori Sommersi per il Trattamento  
delle Acque Reflue**



**Sumber Tiga Jaya**  
Maximizing Performance



**OXY-FLOW**

OXY-FLOW is a valid answer when it comes to oxygenation and homogenizing in systems that treat sewage from civil, industrial and animal breeding complexes, aquaculture or aerated lagoon systems. In addition, it resolves the problem of bad odours in waste water tanks.

#### OPERATION

The waste liquid is conveyed by an electric pump to the Venturi shaped duct of the ejector. The vacuum created draws air through the suction pipe leading outside. Thus obtained, the fluid air mixture has medium-fine bubbles. This achieves a large contact surface that encourages oxygen exchange with great efficiency levels.

OXY-FLOW est une véritable réponse aux travaux d'oxygénation et d'homogénéisation dans les installations de traitement des eaux usées civiles, industrielles et des lisiers, en aquaculture ou dans les lagunes aérées. Par ailleurs il élimine la formation de mauvaises odeurs dans les cuves des eaux usées.

#### FONCTIONNEMENT

A l'aide d'une électropompe l'effluent traverse a conduite de la buse à profil Venturi. La dépression ainsi formée fait un appel d'air à travers le tube d'aspiration communiquant avec l'atmosphère. Le mélange eau/air ainsi obtenu, caractérisé par de moyennes bulles permet une large surface de contact qui favorise un bon rendement d'échange en oxygène.

OXY-FLOW è la soluzione per le esigenze di ossigenazione ed omogeneizzazione negli impianti di trattamento delle acque reflue civili, industriali e zootecniche, in acquacultura, nei lagunaggi aerati. Elimina, inoltre, i problemi di odore nei serbatoi delle acque di scarico.

#### FUNZIONAMENTO

Mediante l'elettropompa il liquido da trattare viene convogliato nel condotto a profilo Venturi dell'eiettore; la depressione che si genera richiama aria attraverso il tubo di aspirazione comunicante con l'atmosfera. La miscela aria liquido così ottenuta, caratterizzata da bolle medio-fini, consente un'ampia superficie di contatto che favorisce lo scambio dell'ossigeno con elevati rendimenti.

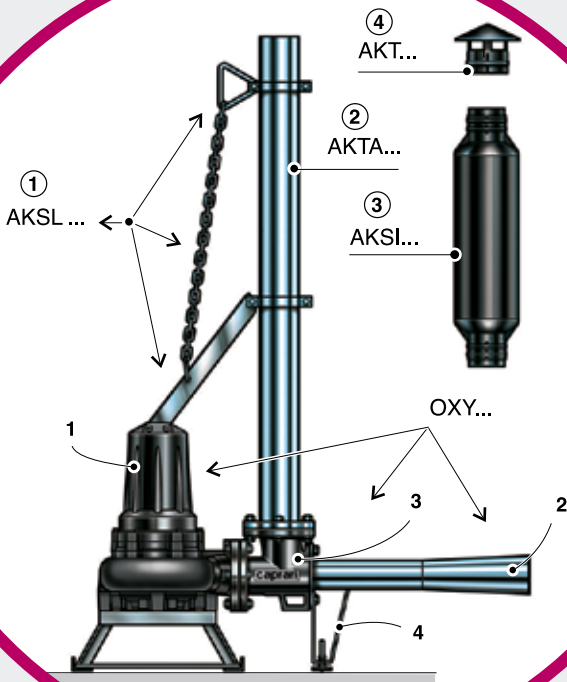

### OXY AERATION ASSEMBLY GROUPE D'AERATION OXY COMPLESSO DI AERAZIONE OXY

- Electric pump with base frame**  
Materials and nomenclature as shown in series K+ catalogue for submersible electric pumps for sewage.  
**Electropompe à châssis de soutien**  
Matériaux et nomenclature comme indiqué sur le catalogue des électropompes submersibles pour liquides chargés série K+.  
**Elettropompa con telaio di sostegno**  
Materiali e nomenclature come da catalogo elettropompe sommergibili per liquidi carichi serie K+.
- Delivery diffuser in stainless steel.**  
**Diffuseur de refoulement** en acier inoxydable.  
**Diffusore di mandata** in acciaio inox.
- Ejector unit in grey cast iron complete with stainless steel diaphragm.**  
**Corps éjecteur** en font grise équipé de **diaphragme** en acier inoxydable.  
**Corpo eiettore** in ghisa grigia completo di **diaframma** in acciaio inox.
- Support foot in stainless steel/rubber.**  
**Nuts and bolts** in stainless steel.  
**Pied** en acier inoxydable / caoutchouc.  
**Vis et écrous** en acier inoxydable.  
**Piede di appoggio** in acciaio inox / gomma  
**Viti e dadi** in acciaio inox.

### OPTIONAL ACCESSORIES ACCESSOIRES SUR DEMANDE ACCESSORI SU RICHIESTA

- AKSL ... - Lifting kit**  
**Brackets, Handle, Chain** in galvanized steel; **nuts and bolts** in stainless steel.  
**AKSL ... - Kit de relevage**  
**Etriers, Poignées, Chaîne** en acier galvanisé; **vis et écrous** en acier inoxydable.  
**AKSL ... - Kit Sollevamento.**  
**Staffa, Maniglia, Catena** in acciaio zincato; **viti e dadi** in acciaio inox.
- AKTA ... - Suction pipe** in galvanized steel; **nuts and bolts** in stainless steel.  
**AKTA ... - Tube d'aspiration** en acier galvanisé; **vis et écrous** en acier inoxydable.  
**AKTA ... - Tubo di aspirazione** in acciaio zincato; **viti e dadi** in acciaio inox.
- AKSI ... - Silencer** in painted steel.  
**AKSI ... - Silencieux** en acier peint.  
**AKSI ... - Silenziatore** in acciaio verniciato.
- AKT ... - Roofing** in painted steel.  
**AKT ... - Couverture** en acier peint.  
**AKT ... - Tettuccio** in acciaio verniciato.

### AERATION ASSEMBLY - GROUPE D'AERATION COMPLESSO DI AERAZIONE

Type Type Tipo	DN	Pump Type Electropompe Type Elettropompa tipo	Hz	Ejector - Ejecteur Eiettore	
				Single - Unique Singolo (OXY-1)	Double - Double Doppio (OXY-2)
OXY 101	/10	KCM100HL+002241N1	50	AK100/57	-
	/11	KCM100HG+002741N1	50	AK100/57	-
	/12	KCM100HD+003541N1	50	AK100/57	-
	/13	KCM100HA+005141N1	50	AK100/57	-
	/14	KSM100HG+001861N1	60	AK100/57	-
/15	KSM100HG+005141N1	60	AK100/57	-	
OXY 152	/10	KCM150LG+006542N1/P	50	AK150/79	-
	/11	KCM150LD+008542N1/P	50	AK150/79	-
	/12	KCM150LA+011242N1/P	50	AK150/79	-
	/15	KSM150LD+006542N1/P	60	AK150/79	-
	/16	KSM150LA+008542N1/P	60	AK150/79	-
	/17	KSM150LG+011242N1/P	60	AK150/79	-
	/13	KCM150NL+014042N1	50	AK150/79	-
/14	KSM150NA+013062N1	60	AK150/79	-	
OXY 252	/11	KCD200NG+018042N1	50	-	AK150/200/D
	/12	KCD200ND+020042N1	50	-	AK150/200/D
	/13	KCD200NA+025042N1	50	-	AK150/200/D
	/14	KSD200NL+025042N1	60	-	AK150/200/D

### JET SHAPE - FORME DU JET - FORMA DEL GETTO

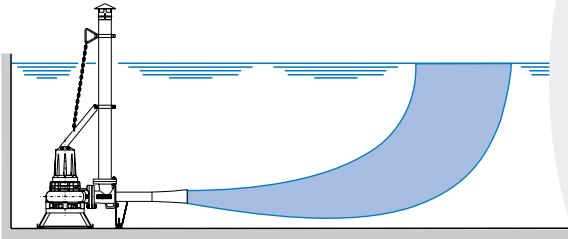

Prevent the jet from directly hitting the walls or obstructions in general. This would cause fine air bubbles to cluster together into larger bubbles and the oxygenation process would lose on efficiency.

*Eviter le contact direct du jet avec les murs ou obstacles en général. Ceci provoque une coalescence des fines bulles d'air en grosses bulles avec une perte de rendement du processus de d'oxygénation.*

**Evitare che il getto impatti direttamente su pareti o ostacoli in generale. Ciò causerebbe aggregazione delle bolle d'aria fini in bolle più grosse con perdita di rendimento del processo di ossigenazione.**

### PERFORMANCE RANGES - CHAMPS DE PERFORMANCES CAMPI DI PRESTAZIONE

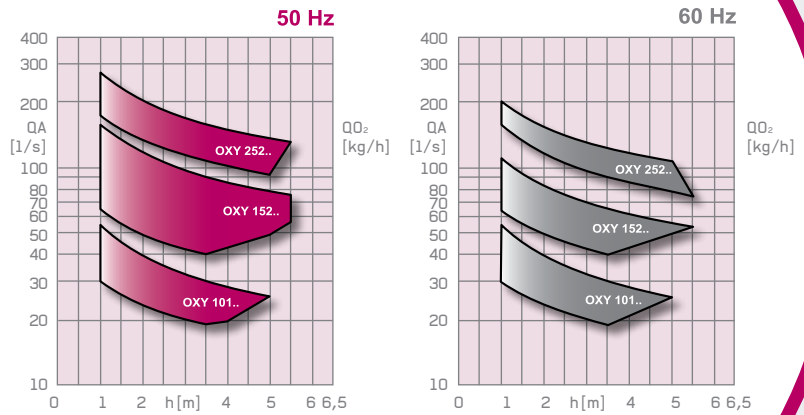

### SUBMERSION - CHARGE D'EAU - BATTENTE

**QA** = Air suction capacity - Air aspiré - Aria aspirata

**QO<sub>2</sub>** = Oxygen content within air capacity  
Contenu d'oxygène dans l'air aspiré  
Contenuto ossigeno nell'aria aspirata

**C** Oxygen absorption by the liquid occurs naturally without aerosol effect.  
*Le transfert d'oxygène à l'affluent se produit naturellement sans effet aérosol.*  
**L'assorbimento di ossigeno da parte del liquido avviene in modo naturale senza effetti aerosol.**

**C** The process is completed by homogenization through circulation under the impulse of the output speed of the mixture as it leaves the diffuser pipe. This prevents the risk of setting and the relative anaerobic phenomena.  
*Ce processus est complété par une homogénéisation dû à la circulation du flide en sortie du diffuseur, évitant le risque de sédimentation et l'amorçage desphénomènes anaérobies.*  
**Il processo si completa con la omogeneizzazione per circolazione sotto l'impulso delle velocità di uscita della miscela dal tubo diffusore evitando il pericolo di sedimentazioni con innesco di fenomeni anaerobici.**

**C** Compact and simple to install, OXY-FLOW can be used in tanks of any shape or size.  
*La dimension compacte et la simplicité d'installation de l'OXY-FLOW permet son utilisation dans des bassins de toutes formes et de toutes dimensions.*  
**La compattezza e la semplicità di installazione dell'OXY-FLOW consente l'utilizzo in vasche di qualsiasi forma e dimensioni.**

**C** The system is immersed in the treated fluid and is therefore fairly silent. The sound level can be further improved by use of a "silencer".  
*Le système est immergé dans l'effluent, et il est donc peu bruyant; le niveau sonore peut être encore réduit grâce à l'utilisation d'un "silencieux".*  
**Il sistema è immerso nel liquido trattato per cui risulta poco rumoroso; il livello sonoro è ulteriormente migliorabile con l'impiego del "silenziatore".**



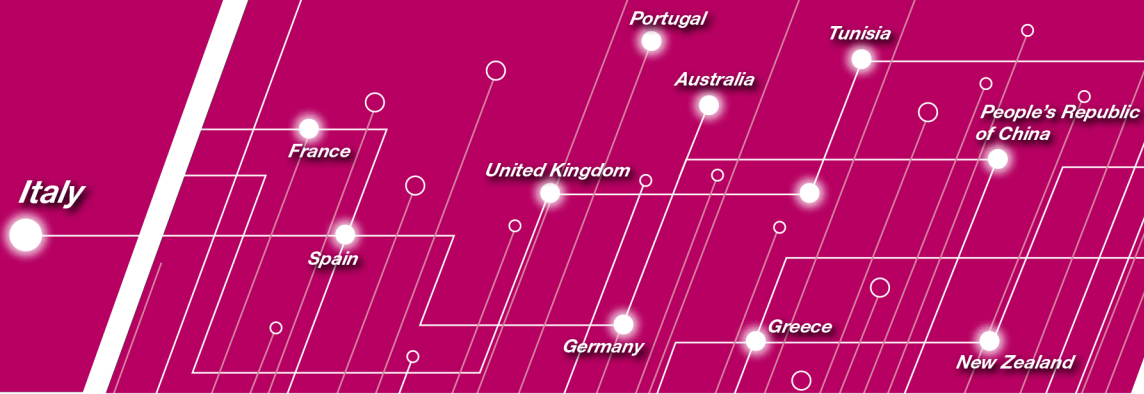

**CAPRARI SPA** Modena (Italy) • **CAPRARI FRANCE SARL** Maurepas - Paris (France) • **BOMBAS CAPRARI SA** Alcalà de Henares Madrid (Spain) • **CAPRARI PUMPS (U.K.) LTD** Peterborough (United Kingdom) • **CAPRARI PUMPEN GMBH** Fürth/Bayern (Germany) • **CAPRARI PORTUGAL LDA** Santarém (Portugal) • **CAPRARI PUMPS AUSTRALIA PTY LTD** Beverley SA (Australia) • **CAPRARI HELLAS SA** Thessaloniki (Greece) • **CAPRARI TUNISIE SA** Ben Arous (Tunisia) • **CAPRARI PUMPS (SHANGHAI) CO LTD** Shanghai (People's Republic of China) • **CAPRARI PUMPS NEW ZEALAND** Christchurch (New Zealand)

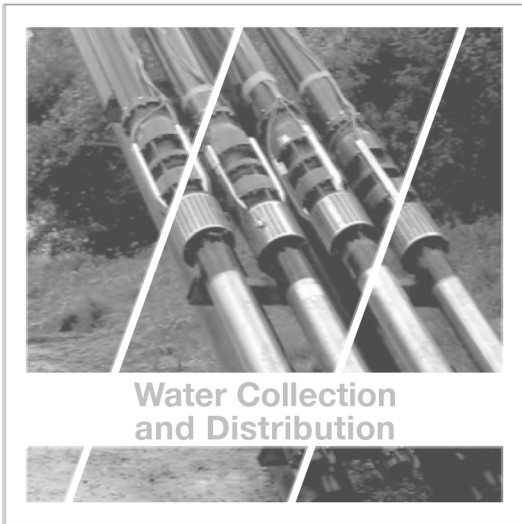

**Water Collection and Distribution**

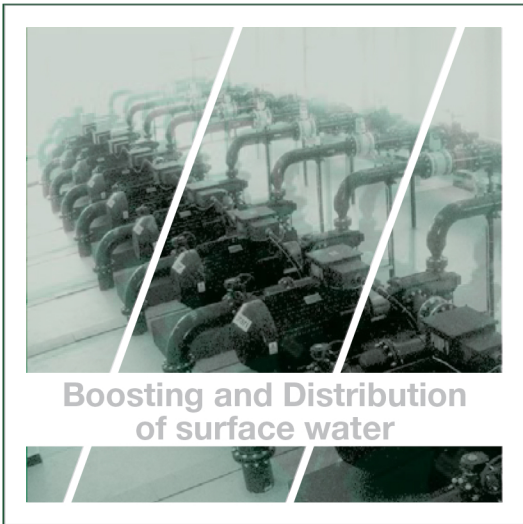

**Boosting and Distribution of surface water**



**Wastewater Transport and Treatment**



**Pump Control Technology**

**caprari**

pumping power



**Sumber Tiga Jaya**  
Maximizing Performance

**For Information**  
Jl. Bukit Indah Lontar Rk 3 No. 36, Surabaya  
+62 31 9914 3626  
mail.support@sumbertigajaya.com  
[www.sumbertigajaya.com](http://www.sumbertigajaya.com)